

# Recent results on $V_{us}$ from KLOE, KTeV and NA48

*Venelin Kozhuharov*

*University of Sofia “St. Kl. Ohridski” / JINR Dubna*

*Heavy Quarks and Leptons 2006*

*19.10.2006*

# Overview

- CKM matrix
- Extraction of  $V_{us}$
- Results
- Conclusion

# CKM matrix

- Connects the weak interactions eigenstates with the quark flavour eigenstates

$$\begin{pmatrix} d' \\ s' \\ b' \end{pmatrix} = \begin{pmatrix} V_{ud} & V_{us} & V_{ub} \\ V_{cd} & V_{cs} & V_{cb} \\ V_{td} & V_{ts} & V_{tb} \end{pmatrix} \begin{pmatrix} d \\ s \\ b \end{pmatrix}$$

- The oldest known element:  $V_{us}$  – Cabibbo angle
- In the absence of new physics (fourth generation) the matrix is unitary

# CKM matrix: Unitarity

- First row:  $|V_{ud}|^2 + |V_{us}|^2 + |V_{ub}|^2 = 1 + \delta$
  - PDG 2004 data
    - $V_{ud} = 0.9738(5)$   
*from super-allowed  $0^+ \rightarrow 0^+$  nuclear transitions*
    - $V_{us} = 0.2195(25)$   
*from  $Kl3$  decays*
    - $V_{ub} = 0.00367(47)$   
*negligible contribution to the unitarity relation*
- $\delta = (3.5 \pm 1.5) * 10^{-3}$**
- with uncertainty from  $V_{us}$  of 0.0010*
- More information desirable

# Determination of $V_{us}$ : KI3

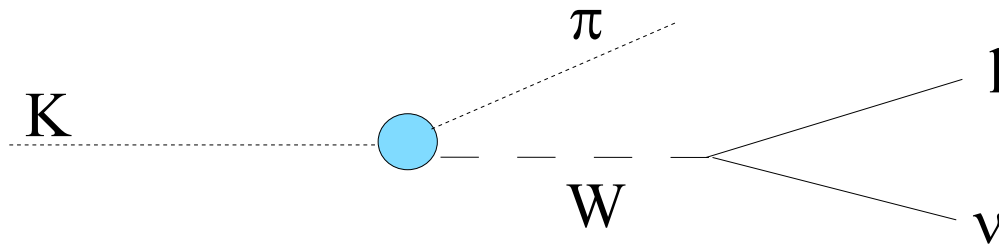

$$|V_{us}| = \sqrt{\frac{128 \pi^3 Br(K_{e3(\gamma)}) / \tau_K}{C^2 G_F^2 M_K^5 S_{EW} (1 + \delta_K^l + \delta_{SU2}) I_K}} * \frac{1}{f_{+(0)}^{K\pi}}$$

where

- $Br(K_{e3(\gamma)})$  – the experimentally measured branching
- $\tau_K$  – kaon lifetime
- $C^2=1$  for  $K_L$  and  $C^2=1/2$  for  $K^\pm$
- $I_K$  – mode and form-factor dependent phase space integrals
- $f_{+}^{K\pi}(0)$  form factor value at  $t=0$
- $S_{EW}$ ,  $\delta_K^l$ ,  $\delta_{SU2}$  – short- and long- distance radiative corrections and SU2 breaking corrections

# Determination of $V_{us}$

- Ratio of kaon and pion leptonic decays

The diagram shows a meson (K or pi+) on the left, represented by a horizontal line that splits into a dashed line labeled W+. From the W+ vertex, two arrows branch out: one pointing up and right to a lepton (mu+ or e+), and one pointing down and right to a neutrino (nu).

$$\frac{\Gamma(K \rightarrow \mu \nu)}{\Gamma(\pi \rightarrow \mu \nu)} = \frac{|V_{us}|^2}{|V_{ud}|^2} \frac{M_K \left(1 - \frac{m_\mu^2}{m_K^2}\right)^2}{M_\pi \left(1 - \frac{m_\mu^2}{m_\pi^2}\right)^2} \frac{f_K^2}{f_\pi^2} * (1 - \delta_{EW})$$

where

- $f_\pi$  and  $f_K$  are the pion and the kaon decay constants
- $\delta_{EM} = 0.0070 \pm 0.0035$  – arising from the radiative corrections
- Hyperon semileptonic decays
  - Analogous to the kaon semileptonic decays
  - Discussed in details in the talk of Rainer Wanke

# Experiments

- The interplay between three experiments in the last years contributed to the measurement of  $V_{us}$  and the understanding of the CKM unitarity

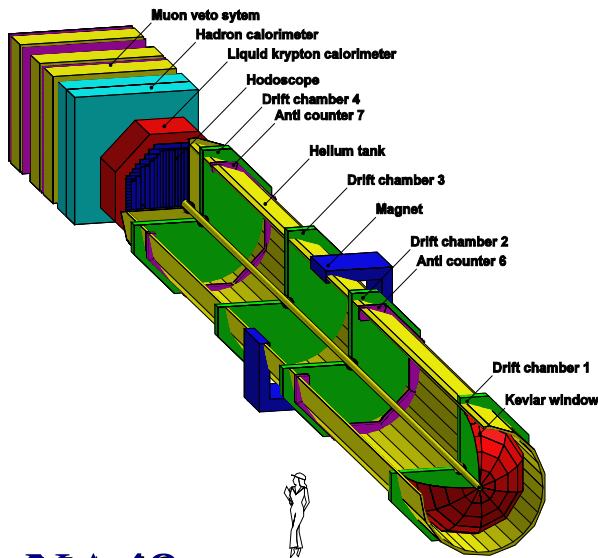

## NA48

*Kaon decays in flight*

$K^0$  and  $K^\pm$

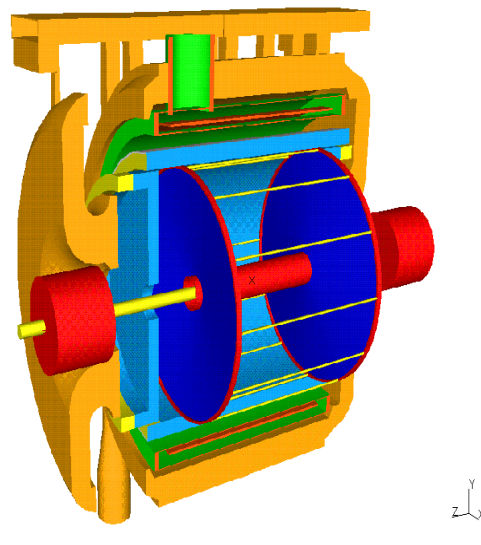

## KLOE

*Tagged kaons from  $\phi$  decays*

$K^0$  and  $K^\pm$

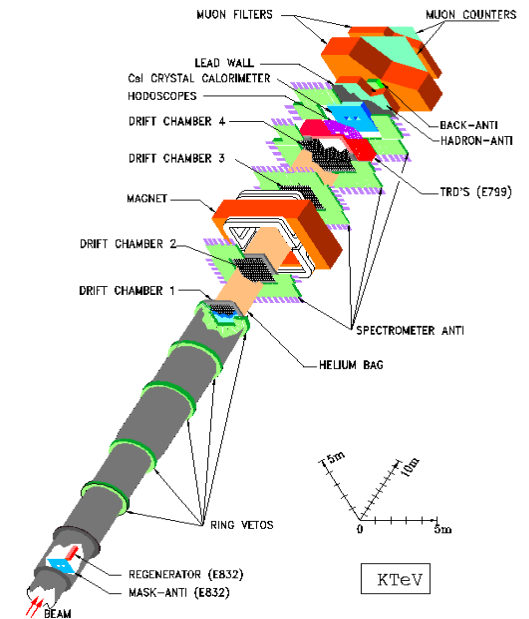

## KTeV

*Kaon decays in flight*

*Only  $K^0$*

# Kaon lifetime

- KL lifetime – *two new measurements by KLOE*
  - Measurement using  $K_L \rightarrow \pi^0 \pi^0 \pi^0$  decays
  - Measurement using all main decay modes

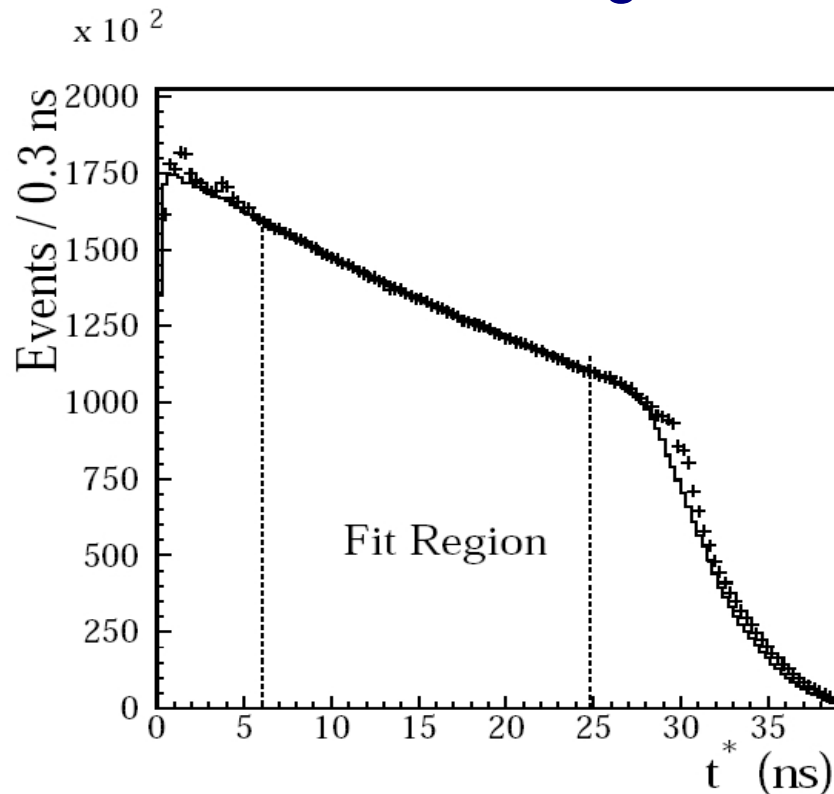

PDG2004	$51.5 \pm 0.4$
KLOE KL branchings	$50.72 \pm 0.37$
KLOE – 3pi0	$50.92 \pm 0.30$

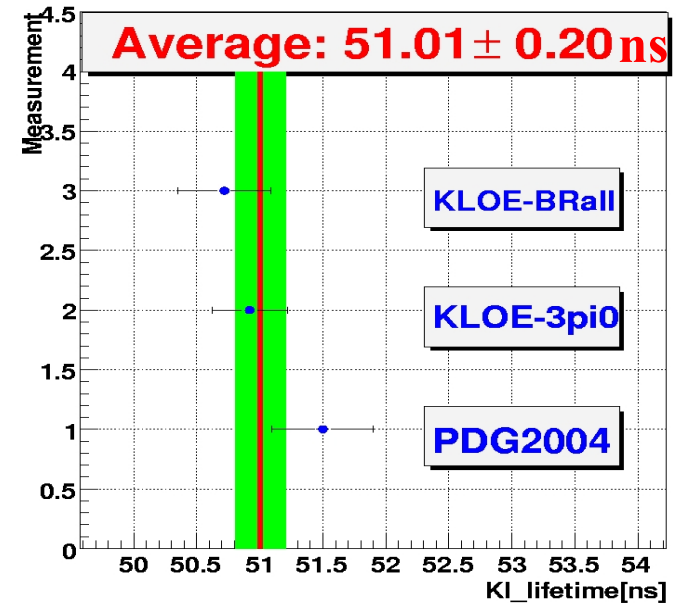

# Kaon lifetime

- KS lifetime:

- Most precise measurements by NA48 and KTeV – already existing in 2004
- Using the PDG value –  $\tau_S = 0.8958(5) * 10^{-10}s$

- K+- lifetime

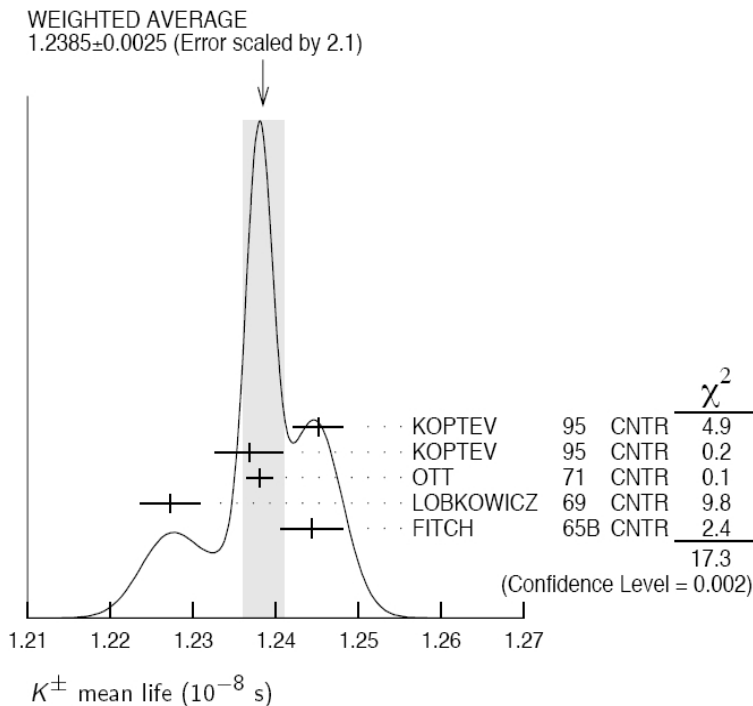

Discrepancies between the different measurements

Preliminary result by KLOE presented at Moriond-2006:

$$\tau_{K^\pm} = (1.2336 \pm 0.0078) * 10^{-8} s$$

waiting for a final result

Using the PDG result

# Form factor measurements

- Parametrizations:  $f_{+(t)} = f_{+(0)} \left( 1 + \lambda' \frac{t}{m_\pi^2} + \frac{\lambda''}{2} \frac{t^2}{m_\pi^2} \right) = f_{+(0)} \left( \frac{M_V^2}{M_V^2 - t} \right)$
- Using  $5.6 \cdot 10^6$  events NA48 has performed a measurement of the KLe3 form-factors

Data – MC comparison for  $\lambda_+ = 0.0288$  and no quadratic term

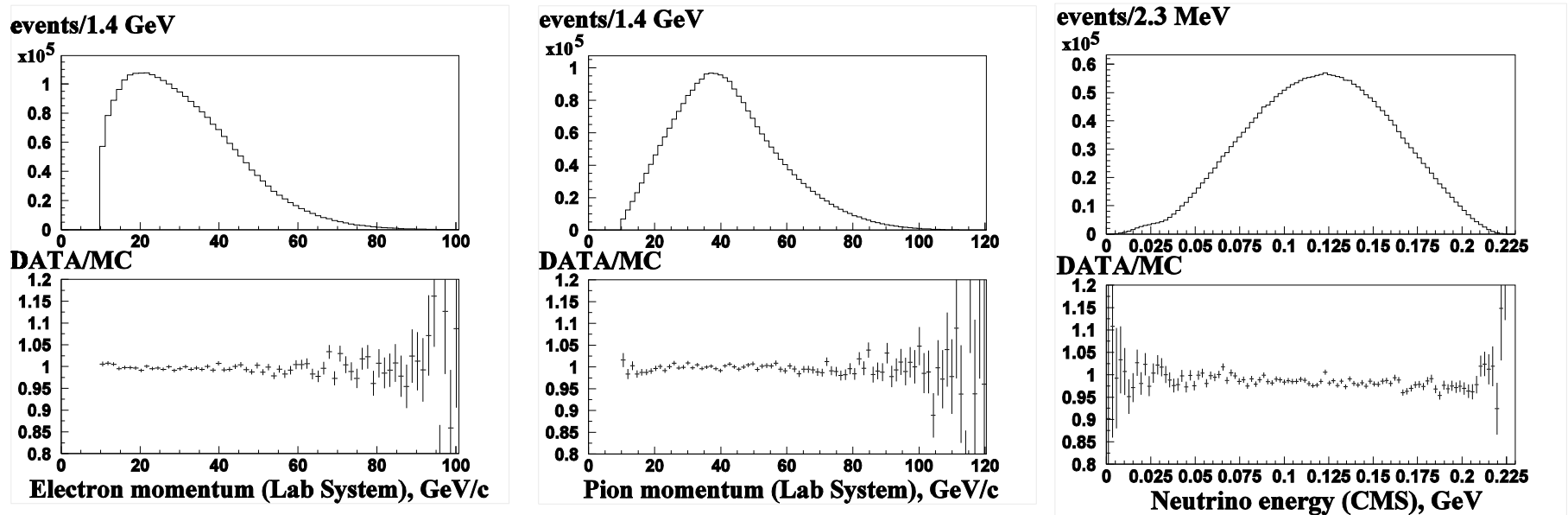

- The analysis doesn't show evidence for the presence of quadratic term
- This result was in contradiction with the measurement of KTeV

# Form factor measurements

- The phase space integrals depend on the parametrization of the form-factors

<i>KLe3 form factors</i>	$\lambda'_+$	$\lambda''_+$	Mass the pole [MeV]
NA48 – 2004	$0.0280 \pm 0.0024$	$0.0004 \pm 0.0009$	$859 \pm 18$
KTeV – 2004	$0.02167 \pm 0.0020$	$0.0029 \pm 0.0008$	$881 \pm 7.1$
KLOE – 2006	$0.0255 \pm 0.0018$	$0.0014 \pm 0.0008$	$870 \pm 9.2$

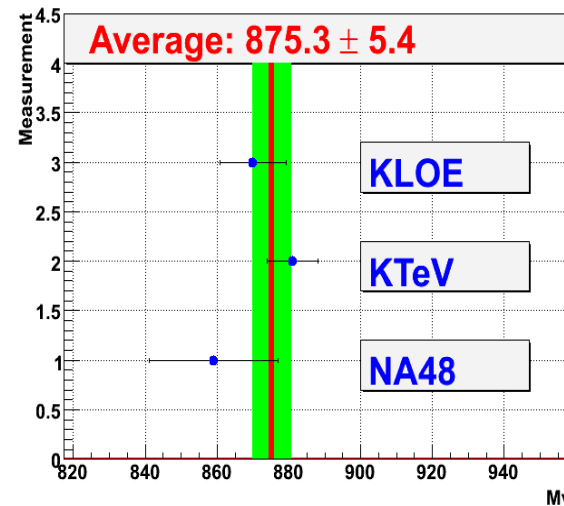
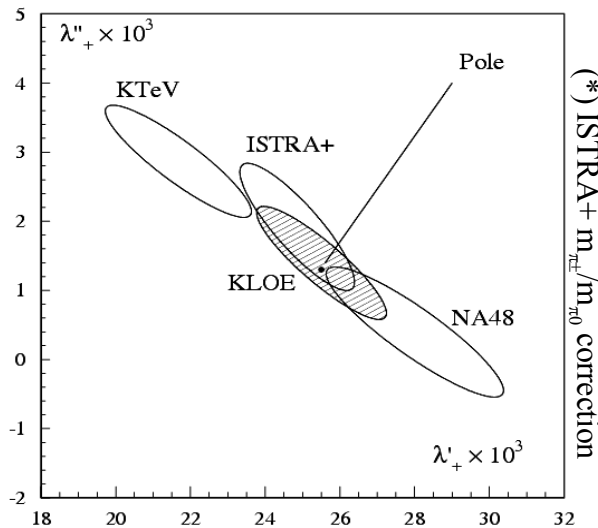

- The recent measurements from KLOE are closer to the NA48 results

# Phase space integrals

- The phase space integrals depend on the parametrization of the form-factors. Different values for the form factors give different values for the phase space integrals for  $K^0e3$ 
  - Using new calculations by KTeV collaboration diminish the model dependency:

$$I_{K^0e3} = 0.10262(32)$$

- Between the pole parametrization from KLOE ( $I_{K^0e3} = 0.1032(2)$ ) and linear from NA48 ( $I_{K^0e3} = 0.1034(6)$ ) and quadratic from KTeV ( $I_{K^0e3} = 0.1023(7)$ )
- $K^0\mu3$ : using the KTeV quadratic form-factor parametrization
$$I_{K^0\mu3} = 0.06777(53)$$
- $K^\pm e3$ : using ISTRA form factor measurements  $I_{K^\pm e3} = 0.1061(8)$

# Theoretical inputs

- First estimate of  $f_+(0)$  done by Leutwyler and Roos in 84  
 $\chi$ PT calculation

$$f_+^{K^0\pi^-}(0) = (0.961 \pm 0.008) \quad f_+^{K^+\pi^0}(0) = 1.022 * f_+^{K^0\pi^-}(0)$$

- New estimation within  $\chi$ PT at the order of  $p^6$  give higher values (J. Bijnens, P. Talavera and V.Cirigliano)

$$f_+^{K^0\pi^-}(0) = (0.974 \pm 0.012)$$

- Lattice QCD result is consistent with the “classical” estimation

$$f_+^{K^0\pi^+}(0) = (0.960 \pm 0.009)$$

- More information on that topic is definitely desirable

- $S_{EW} = 1.023$  – Short distance EW corrections calculated by Marciano&Sirlin

- $\delta_{SU2} = 0.046 \pm 0.004$  – by Cirigliano et.al and Leutwyler and Roos

# NA48: $K_{L e3}$ branching fraction

- Method: normalizing to all two track events

$$R_e = \frac{Br(K_{e3})}{Br(K \rightarrow 2\text{-tracks})}, \quad Br(K_{e3}) = R_e [1.0048 - Br(K_{3\pi^0})]$$

- External input:  $Br(K_{3\pi^0}) = 0.1969 \pm 0.0026$

- The only different criteria for selecting  $K_{e3}$  events: e-PID

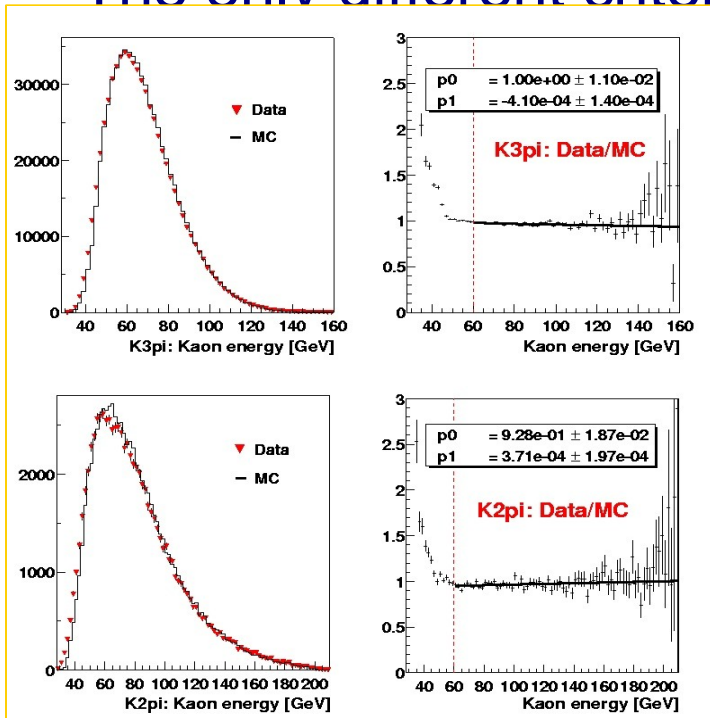
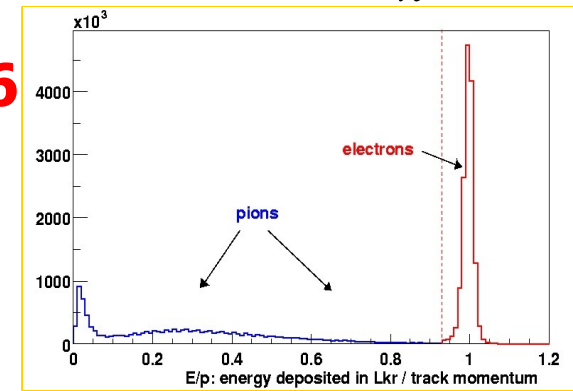

$$R_e = 0.4978 \pm 0.0035$$



$$Br(K_L \rightarrow \pi^\pm e \nu) = 0.4022 \pm 0.0031$$

normalization error - 0.0013

# NA48/2: $K^\pm e3$ branching fraction

- Measuring  $Br(K^\pm \rightarrow \pi^0 e \nu) / Br(K^\pm \rightarrow \pi^\pm \pi^0)$
- Preliminary result:

$$Br(K^\pm \rightarrow \pi^0 e \nu) = (5.14 \pm 0.02_{\text{stat}} \pm 0.06_{\text{syst}})\%$$

- Confirms the deviation from PDG observed by BNL

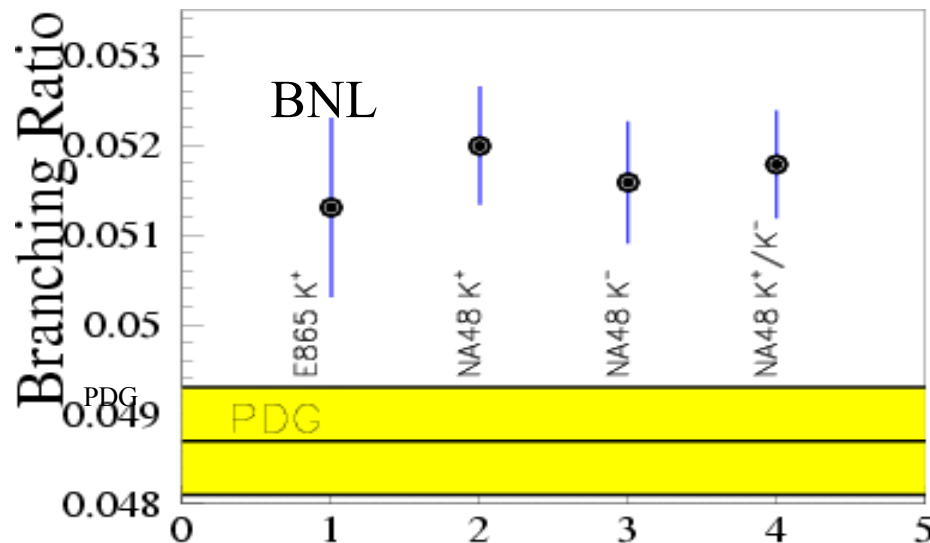

Preliminary result for  $K^\pm \rightarrow \pi^0 \mu \nu$

$$Br(K^\pm \rightarrow \pi^0 \mu \nu) = (3.462 \pm 0.071)\%$$

Final results on the  $Br(K^\pm \rightarrow \pi^0 e \nu)$  and  $Br(K^\pm \rightarrow \pi^0 \mu \nu)$  expected soon

# $K_L$ I3 Branching Fractions: KTeV

- Measure all six largest decay modes in terms of five branching fractions:

$$\Gamma_{K\mu 3} / \Gamma_{Ke 3} \equiv \Gamma(K_L \rightarrow \pi \mu \nu) / \Gamma(K_L \rightarrow \pi e \nu)$$

$$\Gamma_{+-0} / \Gamma_{Ke 3} \equiv \Gamma(K_L \rightarrow \pi^+ \pi^- \pi^0) / \Gamma(K_L \rightarrow \pi e \nu)$$

$$\Gamma_{000} / \Gamma_{Ke 3} \equiv \Gamma(K_L \rightarrow \pi^0 \pi^0 \pi^0) / \Gamma(K_L \rightarrow \pi e \nu)$$

$$\Gamma_{+-} / \Gamma_{Ke 3} \equiv \Gamma(K_L \rightarrow \pi^+ \pi^-) / \Gamma(K_L \rightarrow \pi e \nu)$$

$$\Gamma_{00} / \Gamma_{000} \equiv \Gamma(K_L \rightarrow \pi^0 \pi^0) / \Gamma(K_L \rightarrow \pi^0 \pi^0 \pi^0)$$

- Using the constraint that the remaining width is only 0.03% to convert into branchings

$$\text{BR}(K_L \rightarrow \pi e \nu) = 0.4067 \pm 0.0011$$

$$\text{BR}(K_L \rightarrow \pi \mu \nu) = 0.2701 \pm 0.0009$$

# $K_L$ I3 Branching Fractions: KTeV

## Data – MC comparisons

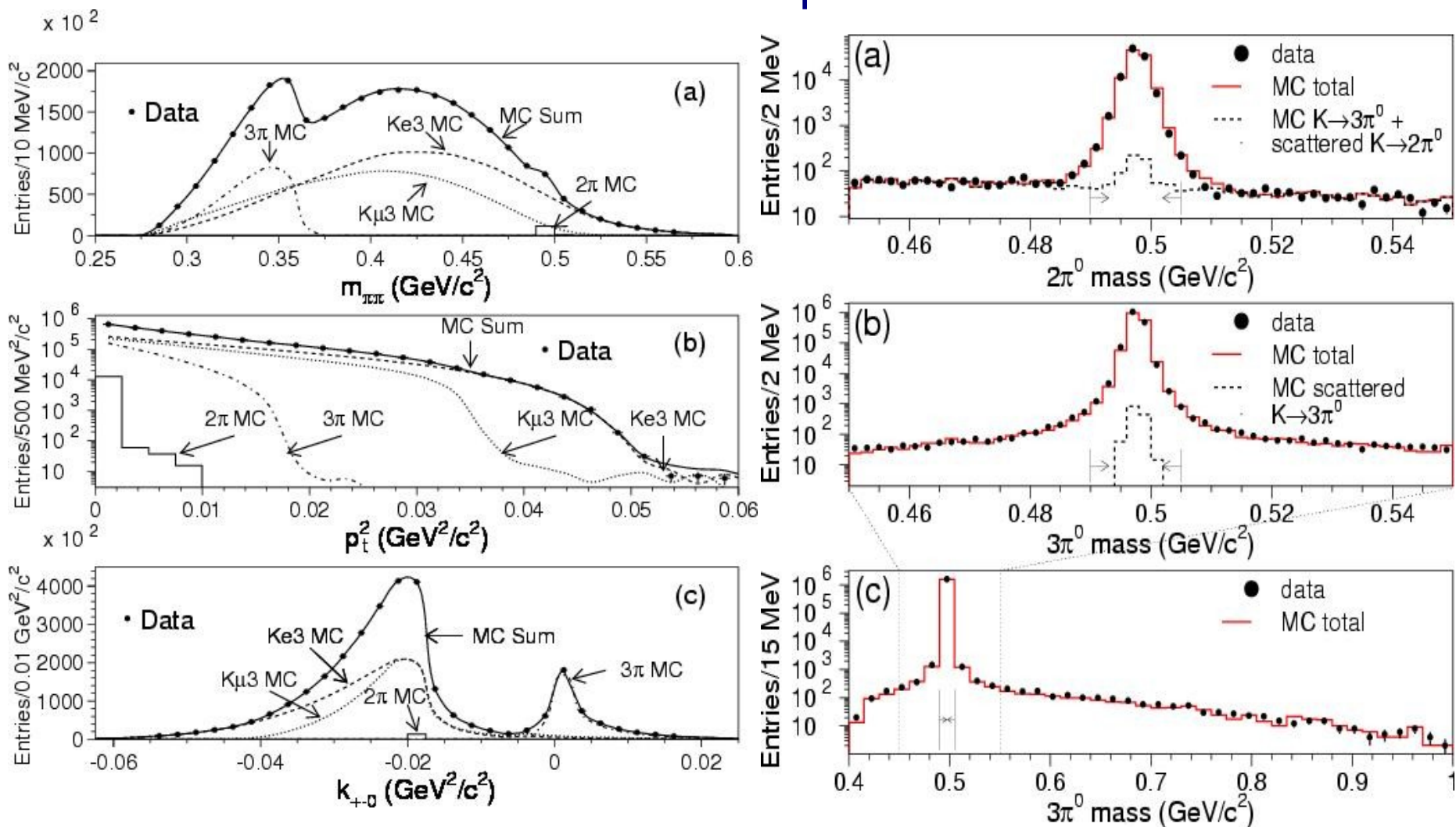

# KI3 Branching Fractions: KLOE

Measured all major KL decay modes

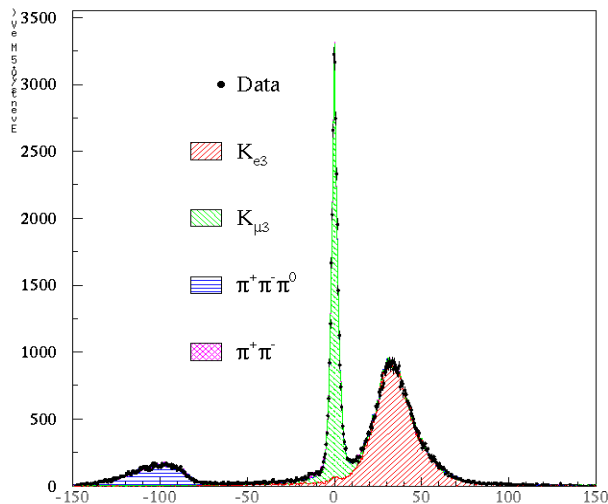

$p_{\text{miss}} - E_{\text{miss}}$  in  $\pi\mu$  or  $\mu\pi$  hyp. (MeV)

$$\text{BR}(K_L \rightarrow \pi e \nu) = 0.4007 \pm 0.0015$$

$$\text{BR}(K_L \rightarrow \pi \mu \nu) = 0.2698 \pm 0.0015$$

Used tagged Ks events

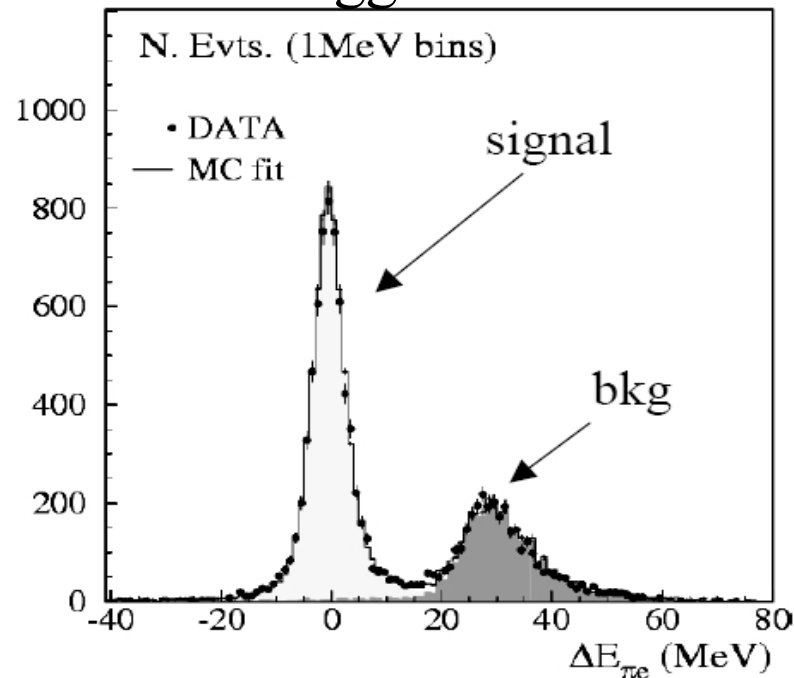

$$\text{BR}(K_s \rightarrow \pi e \nu) = (7.046 \pm 0.091) * 10^{-2}$$

Preliminary results for the charged semileptonic decays

$$\text{BR}(K^\pm \rightarrow \pi^0 e \nu) = (5.047 \pm 0.043) * 10^{-2}$$

$$\text{BR}(K^\pm \rightarrow \pi^0 \mu \nu) = (3.310 \pm 0.048) * 10^{-2}$$

# Kaon semileptonic decays: Summary

<u>Experiment</u>	<u>Decay</u>	<u>Result</u>
KLOE	$K_L e3$	$0.4007 \pm 0.0015$
	$K_L \mu3$	$0.2698 \pm 0.0015$
	$K_S e3$	$(7.046 \pm 0.091) * 10^{-2}$
	$K^\pm e3$	$(5.047 \pm 0.043) * 10^{-2}$
	$K^\pm \mu3$	$(3.310 \pm 0.048) * 10^{-2}$
KTeV	$K_L e3$	$0.4067 \pm 0.0011$
	$K_L \mu3$	$0.2701 \pm 0.0009$
NA48	$K_L e3$	$0.4022 \pm 0.0031$
	$K^\pm e3$	$(5.14 \pm 0.06) * 10^{-2}$
	$K^\pm \mu3$	$(3.462 \pm 0.071) * 10^{-2}$

$K_L$  lifetime  
 $(5.10 \pm 0.02) * 10^{-8} s$

$K_S$  lifetime  
 $(0.8958 \pm 0.0005) * 10^{-10} s$

$K^\pm$  lifetime  
 $(1.2385 \pm 0.0024) * 10^{-8} s$

# Putting the things together

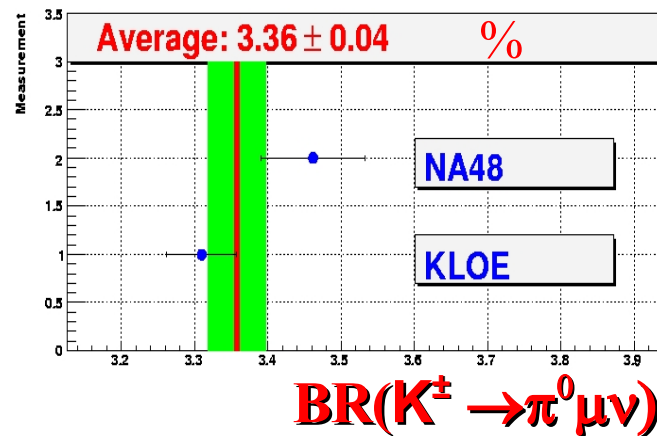
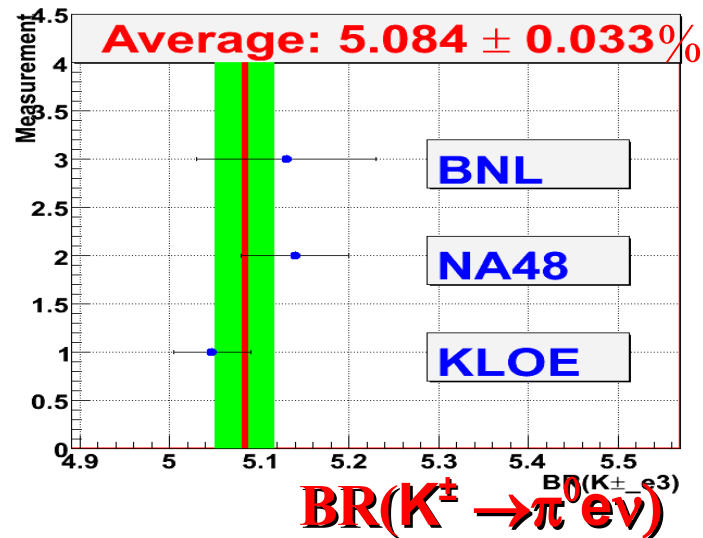
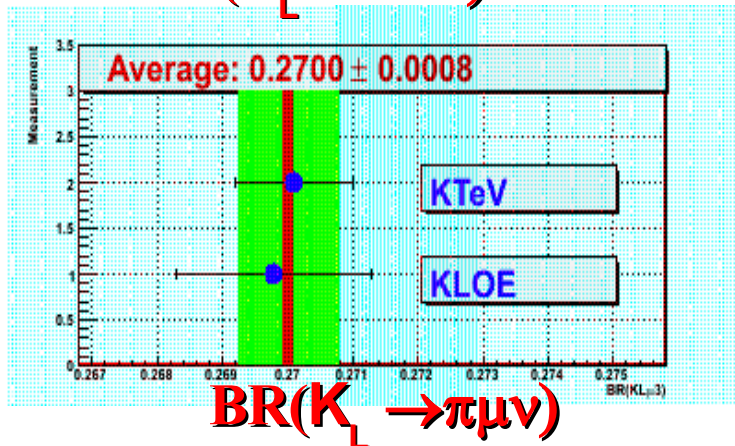
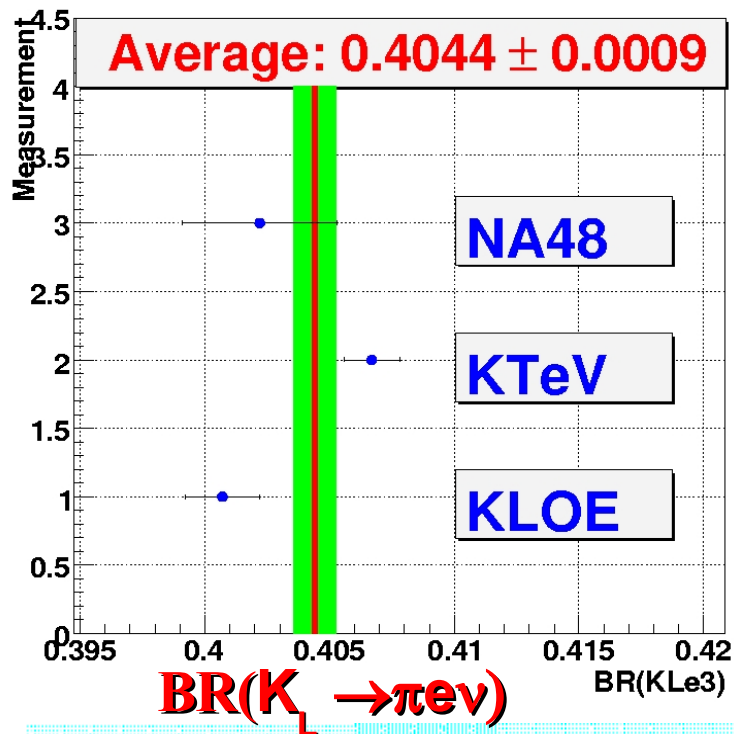

$$BR(K_S e3) = (7.046 \pm 0.091) * 10^{-2}$$

# Vus from kaon semileptonic decays

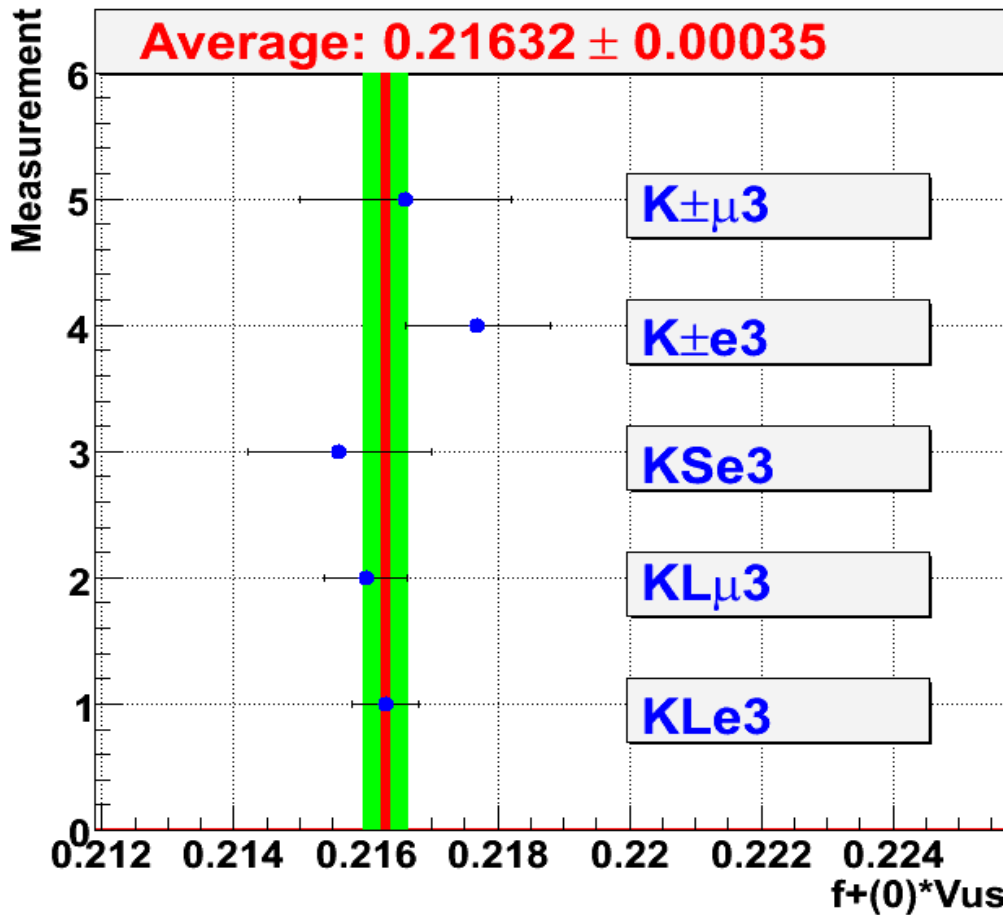

- Using the  $f_+(0)$  by Leutwyler and Roos

$$V_{us} = 0.2251 \pm 0.0019$$

*error coming from  $f_+(0)$*

- Using  $V_{ud} = 0.97377(27)$   
Marciano & Sirlin 2006 PRL96 032002

$$|V_{us}|^2 + |V_{ud}|^2 = 0.9989 \pm 0.0010$$

# Vus from Kμ2 decay

- New result from KLOE for the Br(Kμ2)

$$\text{Br}(K\mu 2(\gamma)) = 0.6366 \pm 0.0009_{\text{stat}} \pm 0.0015_{\text{syst}}$$

- Lattice calculations give

$$f_K / f_\pi = 1.198(3)^{(+16}_{-5)}$$

(MILC Coll. PoS (LAT 2005) 025,2005)

$$|V_{us}| / |V_{ud}| = 0.2294 \pm 0.0026$$

$$|V_{us}| = 0.2234 \pm 0.0026$$

consistent with the results from K13

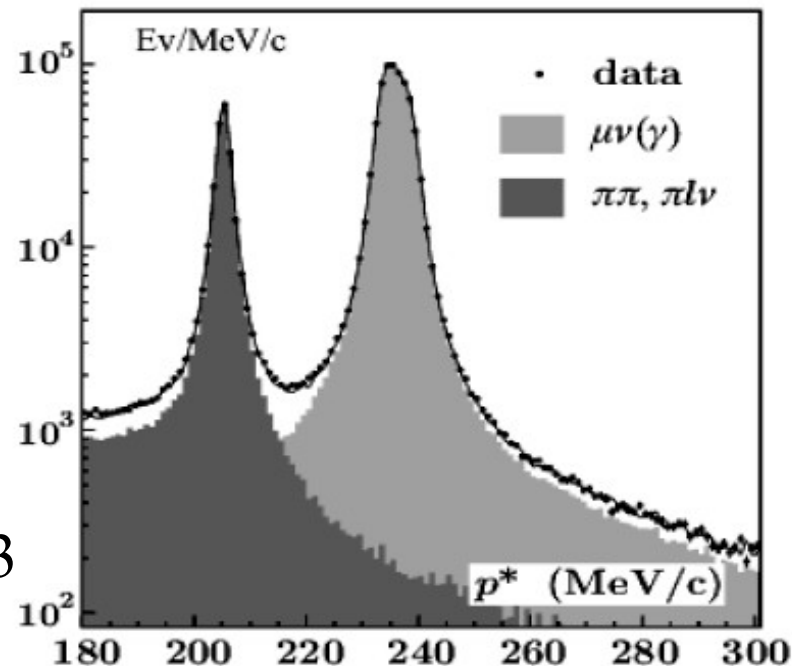

# Conclusion

- NA48, KTeV and KLOE experiments continue to provide a valuable data
- $V_{us}$  has been obtained using two different methods giving consistent values

$$|V_{us}| = 0.2245 \pm 0.0015$$

- The value of  $V_{us}$  is consistent with unitarity of CKM matrix
- However more clarification on the  $Kl3$  form factors desirable
- Further improvement on the  $V_{us}$  measurement depends on the theory